



MAKING STANDARD EXTRA SPECIAL

Retail Price List  
Effective from 1st August 2010



[www.silverline-oe.com](http://www.silverline-oe.com)

**Head Office Open Hours**

Monday to Thursday 08:30 - 17:00,  
Friday 08:30 - 1630

**London Showroom Open Hours**

Monday to Thursday 09:00 - 17:30,  
Friday 09:00 - 17:00

**Contact us:**

**Sales:**

Tel: +44 (0)1638 582 700  
Fax: +44 (0)1638 582 714

enquiries@silverline-oe.com  
enquiries@s-line.co.uk

**London Showroom**

21-22 Great Sutton Street,  
Clerkenwell, London  
EC1V 0DY  
Tel: +44 (0)20 7253 7652

**Marketing:**

Tel: ++44 (0)1638 582 730

**Customer Services:**

Tel: +44 (0)1638 582 709

**Accounts:**

Tel: +44 (0)1638 582736  
Fax: +44 (0)1638 715530

**Visit our websites:**

www.silverline-oe.com  
Our main website

www.silverline-oe.com/go-green/  
Information on re-used material

www.silverlinegraphiccentre.co.uk  
Online information and graphic centre

www.s-line.co.uk  
Website for our design led s:line products

**Order replacement keys**

Simply quote the numbers and letters stamped on the lockface and your keys will be dispatched the same day! Contact our aftersales key service KeysPlease:

Tel: +44(0)20 8343 2943  
Fax: +44(0)20 8343 2994  
sales@keysplease.co.uk  
or order online:  
www.keysplease.co.uk

**Our Mission Statement**

To design, develop and manufacture a range of products to respond to the market demands, optimising supply chain dynamics to deliver a quality effective solution to meet customer expectations.

Silverline have manufactured and supplied steel storage for over 30 years, in this time the company have gone from strength to strength. Staking its claim amongst the elite; Silverline are passionate about manufacturing a highly versatile range of products to fulfil needs in all market levels.

Creating adaptable, sensible and secure products for every kind of working situation we design and specify with a view of the future in mind. All this has gained us a reputation for dependability and value.

Silverline's product portfolio can be viewed at the Showroom in the heart of Clerkenwell, the undisputed heart of design in London.



Certificate number 238



Certificate number 609

## KEY TO SYMBOLS



Guarantee



Drawer Extension



Drawer Carrying Capacity for Suspended Filing



Anti-Tilt Locking Mechanism



m:line Anti-Tilt Locking Mechanism



2 Key Mastered Series



Levelling Feet



Pen Tray



Compartment Tray



Foolscap Standard File



A4 Standard File



Accepts A4 & Foolscap Files



A3 Standard Files



FIRA Certified



### Fast Track Items

Please note fast track products are subject to colour.

Side Tambour and Filing Cabinet fast track items are available in Light Grey only.

Flat Pack Cupboards are available in Light Grey or Brown and Beige



### Go-Green Items

Elements of Executive and m:line Filing Cabinets are manufactured with re-used steel which is better for the environment.

For more information on your CO<sup>2</sup> saving visit [www.silverline-oe.com/go-green/](http://www.silverline-oe.com/go-green/)

4	Kontrax Filing Cabinet
4	Midi Filing Cabinet
4	Executive Filing Cabinet
4	m:line Filing Cabinet
5	A3 Jumbo Filing Cabinet
5	5 Drawer Filing Cabinet
5	Media Filing
6	UK Side Filer
6	Double Side Filer
6	m:line Side Filer - For new Freedom Side Filer see page 16
7	Combi:store - For new Freedom Combi's see page 19
8	Vertical Tambour
8	Kontrax Side Tambour
9	m:line Side Tambour - For new Freedom ST see page 18
10	Kontrax Cupboard
10	Executive Cupboard - For new Freedom cupboard see page 17
10	Open Fronted Cupboard
11	Storage Accessories for products on pages 8-10
12	Pedestals
12	Caddy Pedestals
13	Multi Drawer Units
14	Lockers
NEW	FREEDOM RANGE, . FULLY SUITED SYSTEMS STORAGE
16	Freedom Side Filers
17	Freedom Cupboards
18	Freedom Side Tambours
19	Freedom Combi:store
20	Freedom Storage Accessories
21	Colour Matrix and blind options
22	Product Comparison Reference Matrix
22-23	Internal Dimensions
23	Filing with Silverline Storage Accessories
24	Freedom Capacity Planning & Space Utilisation
25	Freedom Internal Dimensions
26	Railex Files
27	A note about ordering

### Replacement Key Service

For replacement keys please contact our aftersales key service KeysPlease.  
 Tel: 02083432943 Fax: 02083432994  
 Email: [sales@keysplease.co.uk](mailto:sales@keysplease.co.uk)  
 or order online: [www.keysplease.co.uk](http://www.keysplease.co.uk)



# FILING CABINETS

## Kontrax

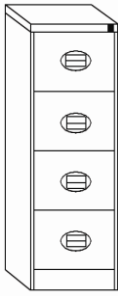

## Midi

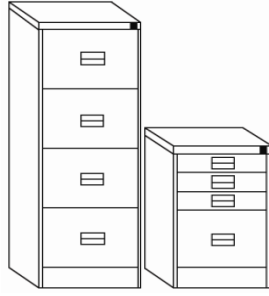

## Executive

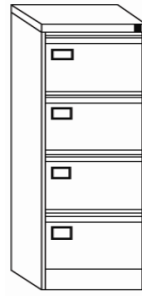

## m:line



	Code	H (mm)	W (mm)	D (mm)	W (kg)	SD Retail (£)	FP	AR Additional Retail (£)	SB	SL
<b>Kontrax</b>										
Four Drawer Foolscap Cabinet	▶▶ FCEC4F	1320	458	622	38.2	292.60	POA		198.50	8.40
Three Drawer Foolscap Cabinet	▶▶ FCEC3F	1009	458	622	31.0	278.60	POA		198.50	8.40
Two Drawer Foolscap Cabinet	▶▶ FCEC2F	711	458	622	22.3	241.70	POA		170.50	8.40
<b>Midi</b>										
Four Drawer Foolscap Cabinet	▶▶ FCMI4F*	1320	458	622	41.5	320.60	POA	14.00	198.50	8.40
Three Drawer Foolscap Cabinet	▶▶ FCMI3F*	1009	458	622	33.2	295.20	POA	10.20	198.50	8.40
Two Drawer Foolscap Cabinet	▶▶ FCMI2F*	711	458	622	24.4	257.00	POA	7.60	170.50	8.40
One Filing + Three Storage Drawers	FCMI1F	711	458	622	31.0	315.50	POA	7.60		8.40
<b>Executive</b>										
Four Drawer Foolscap Cabinet	▶▶ Reused Material FCEX4F*	1320	458	622	44.0	371.50	POA	14.00	198.50	8.40
Three Drawer Foolscap Cabinet	▶▶ Reused Material FCEX3F*	1009	458	622	34.5	341.00	POA	10.20	198.50	8.40
Two Drawer Foolscap Cabinet	▶▶ Reused Material FCEX2F*	711	458	622	25.3	297.70	POA	7.60	170.50	8.40
<b>m:line</b>										
Four Drawer Foolscap Cabinet	▶▶ Reused Material FCLM4F*	1320	458	622	48.0	405.90	POA	14.00	198.50	8.40
Three Drawer Foolscap Cabinet	▶▶ Reused Material FCLM3F*	1009	458	622	37.5	379.20	POA	10.20	198.50	8.40
Two Drawer Foolscap Cabinet	▶▶ Reused Material FCLM2F*	711	458	622	27.4	343.50	POA	7.60	170.50	8.40
1 Filing + 3 Storage Drawers	▶▶ Reused Material FCLM1F	711	458	622	31.3	399.50	POA	7.60		8.40

\* A4 Option Available (amend code by replacing F for A) Please note A4 filing cabinets width is 398mm

## ACCESSORIES

	Code	Pack Size	Retail
Foolscap Divider Kit (Midi & Executive)	FAMIF3SD023	Pack 3	26.70
Foolscap Divider Kit (Midi & Executive)	FAMIF1SD023	Pack 1	16.50
A4 Divider Kit (Midi & Executive)	FAMIA3SD023	Pack 3	26.70
A4 Divider Kit (Midi & Executive)	FAMIA1SD023	Pack 1	16.50
Foolscap Divider Plates (m:line)	FALMF5SD023	Pack 5	30.50
Foolscap Divider Plates (m:line)	FALMF3SD023	Pack 3	21.60
Foolscap Divider Plates (m:line)	FALMF1SD023	Pack 1	11.50

## Coding Key (add the required option code to the end of your chosen product code)

Standard (no options)	SD
Flatpacked	FP
A4 Conversion Rail	AR
Security Bar	SB
Same Lock Number	SL

# MEDIA FILING / CARD INDEX

## 8 drawer

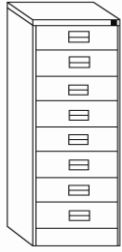

## 6 drawer

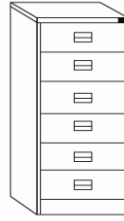

## 5 drawer

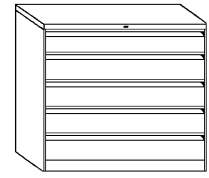

	Code	H (mm)	W (mm)	D (mm)	W (kg)	SD Retail (£)	SL Additional Retail (£)
<b>8 Drawer Unit</b>							
8 Drawer A6 Card Index Filing Cabinet	CIUR86	1320	398	622	71.0	1038.70	8.40
<b>6 Drawer Unit</b>							
6 Drawer A5 Card Index Filing Cabinet	CIUR65	1320	550	622	70.0	1028.50	8.40
<b>5 Drawer Unit</b>							
5 Drawer A5 Card Index Filing Cabinet	CIUR55	1320	760	465	78.0	1156.60	8.40

## ACCESSORIES

	Code	Pack Size	Retail
Divider Plates for 8 drawer unit	IA86D5SD023	5	38.40
Divider Plates for 6 drawer unit	IA65D5SD023	5	44.80
Divider Plates for 5 drawer unit	IA55D5SD023	5	52.50

# A3 JUMBO & 5 DRAWER FILING CABINETS

## A3

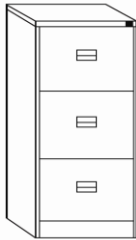

## 5 Drawer



	Code	H (mm)	W (mm)	D (mm)	W (kg)	SD Retail (£)	SL Additional Retail (£)
<b>A 3 Jumbo Filing Cabinet</b>							
A3 Jumbo Filing Cabinet	FCJBA3	1320	550	622	62.0	882.50	8.40
<b>5 Drawer Filing Cabinet</b>							
5 Drawer Foolscap Filing Cabinet	FCUR5F	1500	458	622	59.0	512.30	8.40
5 Drawer A4 Filing Cabinet	FCUR5A	1500	398	622	58.0	512.30	8.40

## ACCESSORIES

	Code	Pack Size	Retail
Compressor Plate for A3 unit	FAA3C1SD023	1	93.50
Divider Plates for 5 drawer Foolscap	FA5FD5SD023	5	67.90
Divider Plates for 5 drawer A4	FA5AD5SD023	5	67.90

## Coding Key (add the required option code to the end of your chosen product code)

Standard (no options)	SD
Same Lock Number	SL

# SIDE FILER UNITS

## Kontrax

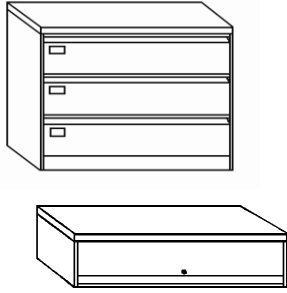

## Double

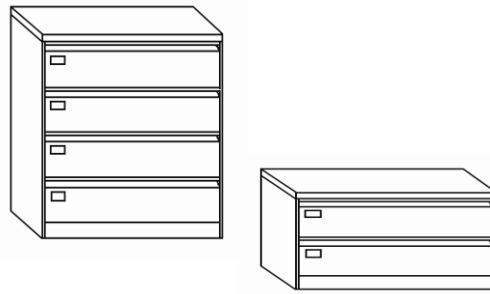

## m:line



	Code	H (mm)	W (mm)	D (mm)	W (kg)	SD Retail (£)	OZ Additional Retail (£)	ST	SL
<b>Kontrax Side Filers</b>									
Four Drawer Side Filer	SFUK4D	1320	800	480	70.0	673.50			8.40
Three Drawer Side Filer	SFUK3D	1009	800	480	54.0	588.30			8.40
Two Drawer Side Filer inc Counter Balance	SFUK2D	690	800	480	47.0	527.70			8.40
Flip Top Unit for Kontrax model only	SFUKFT	420	800	480	16.0	168.10			
<b>Double Side Filers - A4 filing only</b>									
Four Drawer Side Filer	SFCT4D	1320	800	622	78.0	573.40			
Three Drawer Side Filer	SFCT3D	1009	800	622	60.0	499.30			
Two Drawer Side Filer inc Counter Balance	SFCT2D	690	800	622	57.0	453.60			
<b>m:line Side Filers - Discontinued. See page 16 for Freedom Side Filer range</b>									
Four Drawer Side Filer	SFLM4DSD	1320	1003	507	83.0	773.60		163.10	
Three Drawer Side Filer	SFLM3DSD	1009	1003	507	64.0	692.10		163.10	
Two Drawer Side Filer inc Counter Balance	SFLM2DSD	690	1003	507	63.0	596.90		163.10	
Four Drawer Side Filer	SFLM4DOW	1320	800	507	66.5	762.50	207.60		
Three Drawer Side Filer	SFLM3DOW	1009	800	507	51.5	664.90	207.60		
Two Drawer side Filer inc Counter Balance	SFLM2DOW	690	800	507	52.5	526.50	207.60		
<b>m:line Side Filers - Individually Locking - Discontinued. See page 16 for Freedom Side Filer range</b>									
Four Drawer Side Filer with IL	SFLM4DIL	1320	1003	507	83.0	923.20		163.10	
Three Drawer Side Filer with IL	SFLM3DIL	1009	1003	507	64.0	828.00		163.10	
Two Drawer Side Filer with IL	SFLM2DIL	690	1003	507	63.0	719.30		163.10	
Four Drawer Side Filer with IL	SFLM4DIO	1320	800	507	66.5	912.10	207.60		
Three Drawer Side Filer with IL	SFLM3DIO	1009	800	507	51.5	800.80	207.60		
Two Drawer Side Filer with IL	SFLM2DIO	690	800	507	52.5	648.80	207.60		

## ACCESSORIES \* See page 9 for perspex Top options

	Code	Unit Width	Retail
Counter Balance Kit for m:line range	SFLMCKOW	800	64.30
Counter Balance Kit for m:line range	SFLMCKSD	1003	64.30
Counter Balance Kit for Double range	SFCTCB	800	64.30
Counter Balance Kit for Kontrax range	SFUKCK	800	64.30

\* Note: All 2 Drawer Side Filers are fitted with Counter Balance Kits as standard.

Levelling feet will increase unit height by up to 20mm

## Coding Key (add the required option code to the end of your chosen product code)

Standard (no options)	SD
Sloping Top (800mm model)	OZ
Sloping Top (1003mm model)	ST
Same Lock Number	SL

## Cupboard & Drawer



## Flipper and Drawer



**Cupboard and Drawer Units - Discontinued. See page 19 for Freedom Combi:Store range**

	Code	H (mm)	W (mm)	D (mm)	W (kg)	SD Retail (£)	SL Additional Retail (£)
915mm Cupboard + 3 Drawers	CSD378	2125	1003	470	86.0	1078.40	8.40
762mm Cupboard + 3 Drawers	CSD372	1830	1003	470	80.0	1029.30	8.40

**Flipper and Drawer Units - Discontinued. See page 19 for Freedom Combi:Store range**

2 X 376mm Flipper Doors + 4 Drawers	CSD4FU	2125	1003	470	95.0	1281.00	8.40
2 X 376mm Flipper Doors + 3 Drawers	CSD3FU	1830	1003	470	89.0	1160.20	8.40

**ACCESSORIES - Discontinued. See page 19 for Freedom Combi:Store range**

	Code	Pack Size	Retail
Slotted Shelf	CSSHP1SD	1	36.50
Shelf Dividers (pk 5)	CASDP5SD	5	41.30
Slotted Shelf Upstand Kit & 5 Dividers	CSUDKSD	5	42.80

**Coding Key (add the required option code to the end of your chosen product code)**

Standard (no options)	SD
Same Lock Number	SL



# SYSTEMS STORAGE

## Vertical Tambour

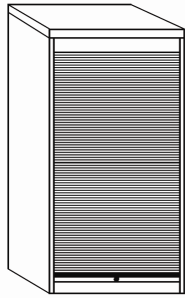

## Kontrax Side Tambour

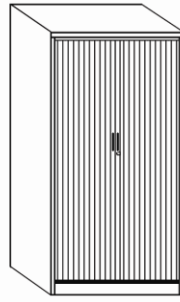

## m:line Side Tambour

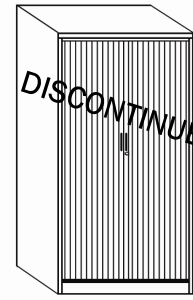

	Code	H (mm)	W (mm)	D (mm)	W (kg)	SD Retail (£)
<b>Vertical Tambours</b>						
2210mm High Steel Tambour Front	SCSV87	2210	<b>920</b>	470	78.0	1101.10
1830mm High Steel Tambour Front	SCSV72	1830	<b>920</b>	470	68.0	1076.40
2210mm High Standard Tambour Front	SCPV87	2210	<b>920</b>	470	74.0	899.70
1830mm High Standard Tambour Front	SCPV72	1830	<b>920</b>	470	65.0	814.40

	Code	H (mm)	W (mm)	D (mm)	W (kg)	OW Retail (£)	OF Additional Retail (£)	OZ
<b>Kontrax Side Tambour 803mm wide</b>								
2000mm High Tambour	SCST7EOW	2000	<b>803</b>	507	61.0	503.50	50.30	201.00
1651mm High Tambour	SCST6EOW	1651	<b>803</b>	507	53.0	485.30	50.30	201.00
1320mm High Tambour	SCST9EOW	1320	<b>803</b>	507	42.0	462.20	50.30	201.00
1016mm High Tambour	SCST4EOW	1016	<b>803</b>	507	36.0	422.00	50.30	201.00
690mm High Tambour	SCST2EOW	690	<b>803</b>	507	28.0	396.50	50.30	201.00

	Code	H (mm)	W (mm)	D (mm)	W (kg)	SD Retail (£)	LF Additional Retail (£)	ST
<b>Kontrax Side Tambour 1003mm wide</b>								
2000mm High Tambour	▶▶ SCST7ESD	2000	<b>1003</b>	507	74.0	508.40	50.30	157.90
1651mm High Tambour	▶▶ SCST6ESD	1651	<b>1003</b>	507	65.0	491.30	50.30	157.90
1320mm High Tambour	▶▶ SCST9ESD	1320	<b>1003</b>	507	50.5	464.60	50.30	157.90
1016mm High Tambour	▶▶ SCST4ESD	1016	<b>1003</b>	507	45.0	428.10	50.30	157.90
690mm High Tambour	▶▶ SCST2ESD	690	<b>1003</b>	507	36.0	398.90	50.30	157.90

	Code	H (mm)	W (mm)	D (mm)	W (kg)	TE Retail (£)	TV Additional Retail (£)	TC	AE
<b>Kontrax Side Tambour 1203mm wide</b>									
2000mm High Tambour	SCST7ETE	2000	<b>1203</b>	507	95.0	785.70	50.30	68.50	89.20
1651mm High Tambour	SCST6ETE	1651	<b>1203</b>	507	83.0	682.30	50.30	68.50	89.20
1320mm High Tambour	SCST9ETE	1320	<b>1203</b>	507	69.0	644.60	50.30	68.50	89.20
1016mm High Tambour	SCST4ETE	1016	<b>1203</b>	507	58.0	589.90	50.30	68.50	89.20
690mm High Tambour	SCST2ETE	690	<b>1203</b>	507	47.0	574.00	50.30	68.50	

### Coding Key (add the required option code to the end of your chosen product code)

Standard 803mm wide	OW	Standard 1003mm wide	SD	Standard 1203mm wide	TE
Levelling Feet 803mm wide	OF	Levelling Feet 1003mm wide	LF	Levelling Feet 1203mm wide	TV
Sloping Top 803mm wide	OZ	Sloping Top 1003mm wide	ST	2 Frame anti-tilt 1203mm wide	TC
				3 Frame anti-tilt 1203mm wide	AE



# SYSTEMS STORAGE

## m:line Side Tambour 803mm wide. Price includes levelling feet - Discontinued. See page 18 for Freedom Side Tambour range

	Code	H (mm)	W (mm)	D (mm)	W (kg)	OW Retail (£)	OZ Additional Retail (£)
2210mm High Tambour	STLM8OW	2210	<b>803</b>	507	74.0	802.90	201.00
2000mm High Tambour	STLM7OW	2000	<b>803</b>	507	63.0	739.50	201.00
1651mm High Tambour	STLM6OW	1651	<b>803</b>	507	53.0	644.90	201.00
1320mm High Tambour	STLM9OW	1320	<b>803</b>	507	44.0	569.50	201.00
1200mm High Tambour	STLM5OW	1200	<b>803</b>	507	41.0	651.60	201.00
1016mm High Tambour	STLM4OW	1016	<b>803</b>	507	38.0	472.60	201.00
690mm High Tambour	STLM2OW	690	<b>803</b>	507	30.0	446.30	201.00

## m:line Side Tambour 1003mm wide. Price includes levelling feet- Discontinued. See page 18 for Freedom Side Tambour range

	Code	H (mm)	W (mm)	D (mm)	W (kg)	SD Retail (£)	ST Additional Retail (£)
2210mm High Tambour	STLM8SD	2210	<b>1003</b>	507	90.0	799.30	157.90
2000mm High Tambour	STLM7SD	2000	<b>1003</b>	507	74.0	686.80	157.90
1651mm High Tambour	STLM6SD	1651	<b>1003</b>	507	65.0	678.40	157.90
1320mm High Tambour	STLM9SD	1320	<b>1003</b>	507	53.0	628.20	157.90
1200mm High Tambour	STLM5SD	1200	<b>1003</b>	507	49.0	549.40	157.90
1016mm High Tambour	STLM4SD	1016	<b>1003</b>	507	45.0	531.30	157.90
690mm High Tambour	STLM2SD	690	<b>1003</b>	507	36.0	481.00	157.90

## m:line Side Tambour 1203mm wide. Price includes levelling feet- Discontinued. See page 18 for Freedom Side Tambour range

	Code	H (mm)	W (mm)	D (mm)	W (kg)	TE Retail (£)	TC Additional Retail (£)	AE
2210mm High Tambour	STLM8TE	2210	<b>1203</b>	507	111.0	964.40	68.50	89.20
2000mm High Tambour	STLM7TE	2000	<b>1203</b>	507	97.0	863.90	68.50	89.20
1651mm High Tambour	STLM6TE	1651	<b>1203</b>	507	85.0	789.70	68.50	89.20
1320mm High Tambour	STLM9TE	1320	<b>1203</b>	507	71.0	722.70	68.50	89.20
1016mm High Tambour	STLM4TE	1016	<b>1203</b>	507	60.0	666.50	68.50	89.20
690mm High Tambour	STLM2TE	690	<b>1203</b>	507	49.0	659.30	68.50	

## ACCESSORIES

	Code	Width	Retail	
Ice Lime m:line Perspex Top	LMTTA-D13	803mm	POA	*Minimum Quantities apply
Ice Orange m:line Perspex Top	LMTTA-D14	803mm	POA	*Minimum Quantities apply
Ice White m:line Perspex Top	LMTTA-D15	803mm	POA	*Minimum Quantities apply
Ice Lime m:line Perspex Top	LMTTB-D13	1003mm	POA	*Minimum Quantities apply
Ice Orange m:line Perspex Top	LMTTB-D14	1003mm	POA	*Minimum Quantities apply
Ice White m:line Perspex Top	LMTTB-D15	1003mm	POA	*Minimum Quantities apply

## Coding Key (add the required option code to the end of your chosen product code)

Standard 803mm wide	OW	Standard 1003mm wide	SD	Standard 1203mm wide	TE
Sloping Top 803mm wide	OZ	Sloping Top 1003mm wide	ST	2 Frame anti-tilt 1203mm wide	TC
				3 Frame anti-tilt 1203mm wide	AE

Note: Please see page 16 for full blind options and to specify band category

Please ensure end location has sufficient accessibility when specifying 2210mm high units

# CUPBOARDS - See page 17 for Freedom Cupboard range

## Kontrax Cupboard

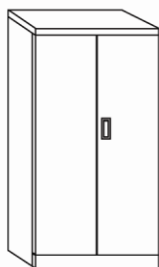

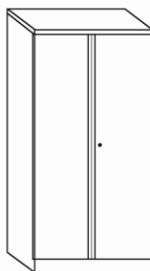

## Executive Cupboard

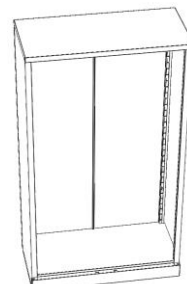

## Open Fronted Cupboard



	Code	H (mm)	W (mm)	D (mm)	W (kg)	SD Retail (£)	LF Additional Retail (£)	SB Additional Retail (£)
<b>Kontrax Cupboard (Assembled)</b>								
2 Door Cupboard with No Shelves	CUEC8A	1950	915	458	52.0	314.80	53.30	209.50
2 Door Cupboard with No Shelves	CUEC7A	1830	915	458	49.0	251.40	53.30	199.30
2 Door Cupboard with No Shelves	CUEC6A	1650	915	458	45.0	248.80	53.30	189.20
2 Door Cupboard with No Shelves	CUEC4A	1020	915	458	31.0	222.20	53.30	139.70
2 Door Cupboard with No Shelves	CUEC1A	690	915	458	24.0	214.60	53.30	134.60
<b>Kontrax Cupboard (Flat Pack)</b>								
2 Door Cupboard + 4 Shelves	CUEC8F	1950	915	458	63.0	339.00	53.30	
2 Door Cupboard + 3 Shelves	 CUEC7F	1830	915	458	58.0	255.20	53.30	
2 Door Cupboard + 1 Shelf	 CUEC4F	1020	915	458	35.0	209.50	53.30	
<b>Executive Cupboard (Assembled)</b>								
2 Door Cupboard with No Shelves	CUEX8A	1950	915	458	53.0	336.40	53.30	209.50
2 Door Cupboard with No Shelves	CUEX7A	1830	915	458	50.0	270.40	53.30	199.30
2 Door Cupboard with No Shelves	CUEX4A	1020	915	458	32.0	236.10	53.30	139.70
<b>Executive Cupboard (Flat Pack)</b>								
2 Door Cupboard + 4 Shelves	CUEX8F	1950	915	458	63.0	388.50	53.30	
2 Door Cupboard + 3 Shelves	CUEX7F	1830	915	458	59.0	281.80	53.30	
2 Door Cupboard + 1 Shelf	CUEX4F	1020	915	458	36.0	223.40	53.30	
<b>Open Fronted Cupboard (Assembled)</b>								
1950mm High Open Fronted Cupboard	CUOF78	1950	915	458	37.0	297.10	53.30	
1830mm High Open Fronted Cupboard	CUOF72	1830	915	458	35.0	245.00	53.30	
1650mm High Open Fronted Cupboard	CUOF65	1650	915	458	29.0	239.90	53.30	
1020mm High Open Fronted Cupboard	CUOF40	1020	915	458	23.5	210.70	53.30	
690mm High Open Fronted Cupboard	CUOF27	690	915	458	17.0	204.40	53.30	

### Coding Key (add the required option code to the end of your chosen product code)

Standard	SD
Levelling Feet	LF
Security Bar	SB

Please see page X for storage accessories including Anti-Tilt

**Note: The base of our Side Tambour and Cupboard units should not be used for storage purposes**

# STORAGE ACCESSORIES

All internals on this page can be used in Kontrax and m:line Side Tambours, Vertical Tambours as well as Open Fronted Cupboards, Kontrax and Executive Double Door Cupboards

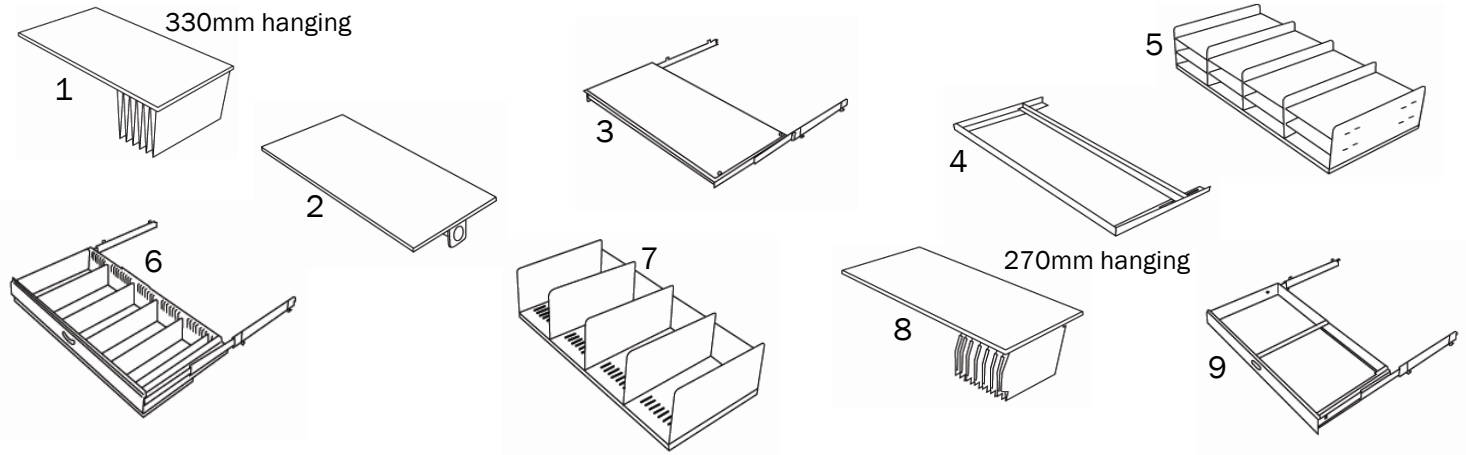

	Code
1. Dual Purpose Shelf (330mm hanging)*	CAPSP1
1. 3 Pk Dual Purpose Shelf*	CAPSP3
2. Wardrobe Shelf	CAWSP1
3. Roll Out Shelf	CARSP1
4. Lateral Filing Frame*	CALFP1
5. Letter Sorter	CALSP1
6. Roll Out Slotted Drawer	CADRP1
6. 5 Pk Slotted Drawer dividers	CADDP5
7. Slotted Shelf	CASSP1
7. 5 Pk Slotted Shelf dividers	CASDP5
8. Dual Purpose Shelf (270mm hanging)*	CAPFP1
9. Roll Out Filing Frame - Standard *	CARFP1

800mm		1000mm		1200mm	
OW		SD		TE	
Retail (£)	Weight (kg)	Retail (£)	Weight (kg)	Retail (£)	Weight (kg)
19.40	3.3	19.40	3.5	47.80	3.8
58.10	9.9	58.10	10.5		
46.50	3.8	46.50	4.0	85.30	4.3
89.10	5.8	89.10	6.0	164.10	6.5
27.10	1.8	28.40	2.0	46.50	2.4
182.20	12.0	195.10	13.0	240.30	13.5
130.50	7.8	131.80	8.0	152.50	8.4
24.50		24.50		24.50	
38.80	4.2	38.80	4.5	73.60	4.9
41.30		41.30		41.30	
42.60	3.8	42.60	4.0	51.70	4.4
				147.30	5.4

9. Roll Out Filing Frame with Anti-tilt *	CARFP1
1200mm wide 2 frame anti-tilt bars	CAATF2
1200mm wide 3 frame anti-tilt bars	CAATF3

800mm		1000mm		1200mm	
OW		SD		AE	
Retail (£)	Weight (kg)	Retail (£)	Weight (kg)	Retail (£)	Weight (kg)
103.40	5	103.40	5.2	151.20^	5.4
				68.50^	
				89.20^	

^ For 1200 wide RSF with Anti Tilt please ensure anti tilt frames are ordered. \* With Suspended Filing

**Internals on this page are supplied in Graphite Grey - 012 as standard**

**Note: The base of our Side Tambour and Cupboard units should not be used for storage purposes**

# DIMENSIONS

	Code
1. Dual Purpose Shelf (330mm hanging)*	CAPSP1
2. Wardrobe Shelf	CAWSP1
3. Roll Out Shelf	CARSP1
4. Lateral Filing Frame*	CALFP1
6. Roll Out Slotted Drawer	CADRP1
7. Slotted Shelf	CASSP1
8. Dual Purpose Shelf (270mm hanging)*	CAPFP1
9. Roll Out Filing Frame with Anti-tilt *	CARFP1

800mm		1000mm		1200mm	
OW		SD		TE	
W(mm)	D(mm)	W(mm)	D(mm)	W(mm)	D(mm)
713	390	913	390	1054	410
713	390	913	390	1054	410
638	385	838	385	1051	410
708	390	908	390	1054	410
590	310	790	310	1004	368
713	390	913	390	1054	410
713	390	913	390	1054	410
600	328	800	328	1020	385

# PEDESTALS

PDBP53

PDBP54

PDUD55

PDUD50

PDDH63

PDDH83

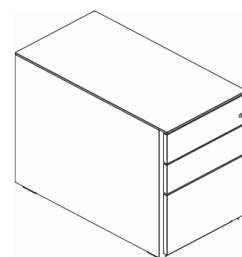
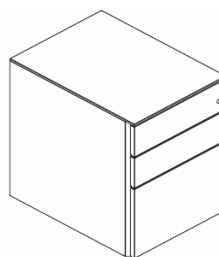
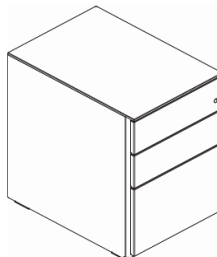
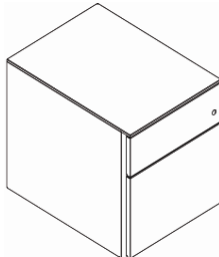
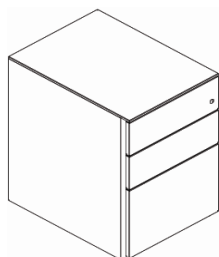
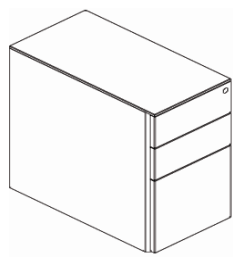

	Code	H (mm)	W (mm)	D (mm)	W (kg)	SD Retail (£)
<b>Beam Pedestal (with Castors) price includes Pen Tray</b>						
2 Personal + 1 Filing Drawer	PDBP53SD*	600	300	570	21.4	240.70
2 Personal + 1 Filing Drawer	PDBP54SD	600	420	570	24.3	243.00
<b>Under Desk Pedestal (with Castors) price includes Pen Tray</b>						
1 Personal + 1 Filing Drawer	PDUD55SD	505	420	570	20.8	233.70
2 Personal + 1 Filing Drawer	PDUD50SD	660	420	570	26.5	245.40
<b>Desk High Pedestal (with Adjustable Feet) price includes Pen Tray</b>						
2 Personal + 1 Filing Drawer	PDDH63SD	690	420	600	27.7	258.20
2 Personal + 1 Filing Drawer	PDDH83SD	690	420	800	31.1	295.60

Looking for a pedestal with a styled handle? Please contact our sales office for information on our s:line pedestals

\* Adjustable Feet allow Desk High Pedestals height to reach 720mm

# CADDY PEDESTALS

PDCB53

PDCB54

PDCU55

PDCU50

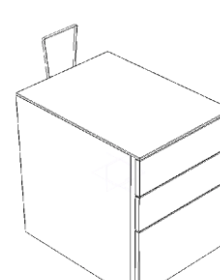
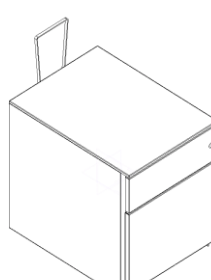
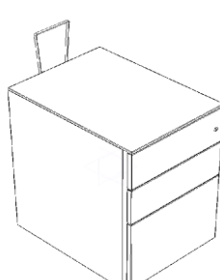
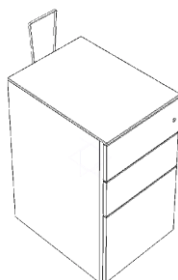

	Code	H (mm)	W (mm)	D (mm)	W (kg)	SD Retail (£)
<b>Beam Pedestal (with Castors) price includes Pen Tray</b>						
2 Personal + 1 Filing Drawer	PDCB53SD*	600	300	570	21.8	350.50
2 Personal + 1 Filing Drawer	PDCB54SD	600	420	570	25.5	351.70
<b>Under Desk Pedestal (with Castors) price includes Pen Tray</b>						
1 Personal + 1 Filing Drawer	PDCU55SD	505	420	570	21.2	343.50
2 Personal + 1 Filing Drawer	PDCU50SD	660	420	570	27.0	356.40

\*Foolscap filing only

Note: There is no surcharge for Silver on Pedestals

# MULTI DRAWER CABINETS

## 5 Drawer



## 10 Drawer

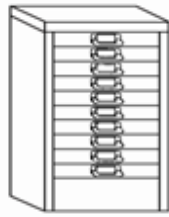

## 15 Drawer

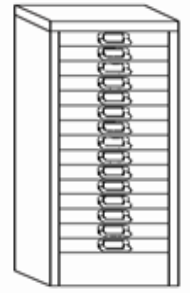

	Code	H (mm)	W (mm)	D (mm)	W (kg)	SD Retail (£)	SL Additional Retail (£)
<b>Non Locking</b>							
5 Drawer Cabinet	MDUR05SD	355	278	408	13.0	81.30	
10 Drawer Cabinet	MDUR10SD	605	278	408	22.0	143.20	
15 Drawer Cabinet	MDUR15SD	866	278	408	30.0	207.50	
<b>Locking</b>							
5 Drawer Locking Cabinet	MDUR05LK	355	278	408	13.5	111.60	8.40
10 Drawer Locking Cabinet	MDUR10LK	605	278	408	22.5	174.70	8.40
15 Drawer Locking Cabinet	MDUR15LK	866	278	408	30.5	239.00	8.40

## ACCESSORIES

	Code	No Of Compartments	Retail
Plastic Insert Tray	MAPT65SD003	16	38.90
Plastic Insert Tray	MAPT85SD003	8	38.90
Plastic Insert Tray	MAPT45SD003	4	38.90

## Coding Key (add the required option code to the end of your chosen product code)

Standard (no options)	SD
Same Lock Number	SL

# LOCKERS

## Locker Range



	Code	H (mm)	W (mm)	D (mm)	W (kg)	SD Retail (£)	HS Additional	CR Retail (£)
<b>Standard Lockers</b>								
Standard Single Door Locker	LK1D22	1780	305	305	18.8	108.20	0.00	22.70
Standard Two Tier Locker	LK2D22	1780	305	305	19.2	125.80	0.00	22.70
Standard Three Tier Locker	LK3D22	1780	305	305	20.4	177.40	0.00	22.70
Standard Four Tier Locker	LK4D22	1780	305	305	21.6	179.90	0.00	22.70
Standard Six Tier Locker	LK6D22	1780	305	305	24.4	217.70	0.00	22.70
Standard Combination Shelf Pack	LKCU12	170	900	305	10.0	124.60		
<b>Deep Lockers</b>								
Deep Single Door Locker	LK1D28	1780	305	458	21.8	132.10	0.00	22.70
Deep Two Tier Locker	LK2D28	1780	305	458	22.2	154.80	0.00	22.70
Deep Three Tier Locker	LK3D28	1780	305	458	23.4	193.80	0.00	22.70
Deep Four Tier Locker	LK4D28	1780	305	458	24.6	196.30	0.00	22.70
Deep Six Tier Locker	LK6D28	1780	305	458	27.4	235.30	0.00	22.70
Deep Combination Shelf Pack	LKCU18	170	900	458	12.0	124.60		

## ACCESSORIES

	Code	Depth	Retail
Sloping Top (Qty of 1-10 ordered)	ST	Standard	68.00
Sloping Top (Qty of 11-25 ordered)	ST	Standard	39.00
Sloping Top (Qty of 26+ ordered)	ST	Standard	26.40
Sloping Top (Qty of 1-10 ordered)	ST	Deep	81.80
Sloping Top (Qty of 11-25 ordered)	ST	Deep	44.00
Sloping Top (Qty of 26+ ordered)	ST	Deep	31.50

## Coding Key (add the required option code to the end of your chosen product code)

Standard (no options)	SD
Hasp and Staple	HS
Coat Rail	CR

**Note: Standard Cam lock is key retained in open position (unlocked)**  
**Nuts and bolts for nesting available. Please contact our sales office**  
**Locker name tags are not included and can not be sourced by Silverline.**

# freedom

A RANGE FOR ALL REASONS

## freedom storage solutions.

- freedom to use as partitioning with a clean back construction.
- freedom to replace damaged panels without replacing the whole unit.
- freedom for style with a unique tambour handle detail.
- freedom of capacity with a 31mm pitching system for internals.
- freedom to match and suit with shared footprints, heights and widths.

### Features

10 year guarantee

Fira certified

Levelling feet as standard

Counter balance as standard on 2 drawer side filers

Clean back construction

Unique styled handle on Side Tambour

8 height levels and 2 widths to choose from for cupboards

8 height levels and 3 widths to choose from for Side Tambours

100% drawer extension on all filing drawers

Anti tilt on all roll out internals fitted as standard

Consistency of footprint and aesthetics

The ability to incorporate selections from our s:l range

2 key mastered series

Choice of individual locking drawers for side filers

Mixed storage compartments for combination units





# FREEDOM SIDE FILER UNITS

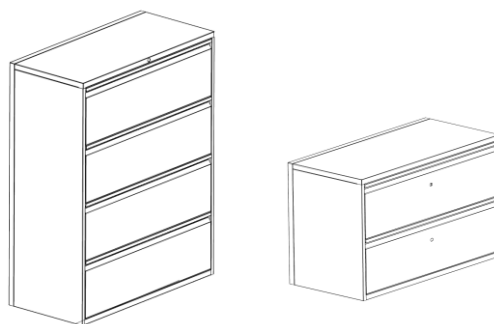

	Code	H (mm)	W (mm)	D (mm)	W (kg)	Retail (£)	CK Additional Retail (£)	SL Additional Retail (£)
<b>Freedom Side Filers</b>								
Four drawer Side Filer	FR40SDD4	1307	1000	470	75.5	850.70	42.90	8.40
Three drawer Side Filer	FR30SDD3	997	1000	470	60.0	726.50	42.90	8.40
Two drawer Side Filer	FR20SDD2	687	1000	470	43.2	556.40		8.40
Four drawer Side Filer	FR400WD4	1307	800	470	65.3	796.10	33.80	8.40
Three drawer Side Filer	FR300WD3	997	800	470	51.7	684.80	33.80	8.40
Two drawer Side Filer	FR200WD2	687	800	470	37.2	502.90		8.40
<b>Freedom Side Filers - Individually Locking</b>								
Four drawer Side Filer - Individually Locking	FR40SDDL4	1307	1000	470	85.3	1055.00	42.90	8.40
Three drawer Side Filer - Individually	FR30SDDL3	997	1000	470	66.0	866.70	42.90	8.40
Two drawer Side Filer - Individually Locking	FR20SDDL2	687	1000	470	47.2	674.10		8.40
Four drawer Side Filer - Individually Locking	FR400WDL4	1307	800	470	73.3	1029.30	33.80	8.40
Three drawer Side Filer - Individually	FR300WDL3	997	800	470	57.7	835.70	33.80	8.40
Two drawer Side Filer - Individually Locking	FR200WDL2	687	800	470	41.2	636.70		8.40

## ACCESSORIES

	Code	Pack Size	Retail
Drawer divider	SLDIV1	Pack 1	8.20

## Coding Key (add the required option code to the end of your chosen product code)

Counter Balance	CK
Same Lock Number	SL

\* Note: All 2 Drawer Side Filers are fitted with Counter Balance Kits as standard

# FREEDOM CUPBOARDS

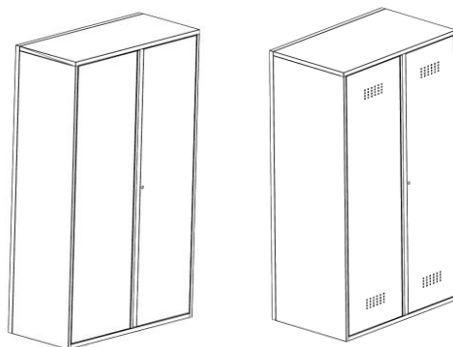

	Code	H (mm)	W (mm)	D (mm)	W (kg)	Retail (£)	CK	SL Additional Retail (£)
<b>Freedom Cupboard (Assembled)</b>								
2 Door Cupboard with No Shelves	FR600WC	1927	800	470	61.0	472.90	33.80	8.40
2 Door Cupboard with No Shelves	FR550WC	1772	800	470	56.8	441.90	33.80	8.40
2 Door Cupboard with No Shelves	FR500WC	1617	800	470	52.8	429.10	33.80	8.40
2 Door Cupboard with No Shelves	FR450WC	1462	800	470	48.7	395.90	33.80	8.40
2 Door Cupboard with No Shelves	FR400WC	1307	800	470	44.5	389.50	33.80	8.40
2 Door Cupboard with No Shelves	FR350WC	1152	800	470	44.0	369.20	33.80	8.40
2 Door Cupboard with No Shelves	FR300WC	997	800	470	36.4	346.70	33.80	8.40
2 Door Cupboard with No Shelves	FR200WC	687	800	470	28.2	315.70	33.80	8.40
<b>Freedom Coat Cupboard (Assembled)</b>								
2 Door Coat Cupboard	FR600WCC	1927	800	600	77.8	878.50		
2 Door Coat Cupboard	FR60SDCC	1927	1000	600	89.7	989.80		

Please see page 20 for Freedom Internals

## Coding Key (add the required option code to the end of your chosen product code)

Same Lock Number

SL

# FREEDOM SIDE TAMBOURS

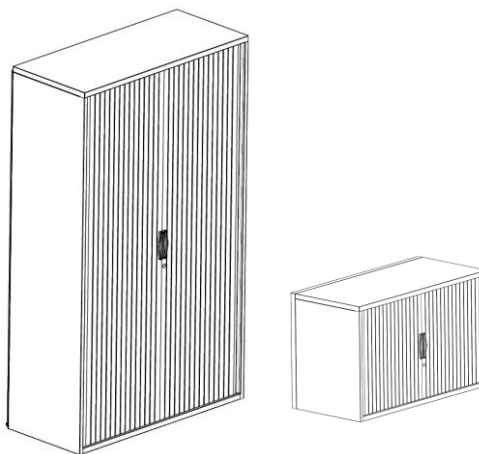

	Code	H (mm)	W (mm)	D (mm)	W (kg)	Retail (£)	CK Additional Retail (£)
<b>Freedom Side Tambour 800mm wide.</b> Price includes levelling feet							
1927mm High Tambour	FR600WT	1927	<b>800</b>	470	75.4	620.60	33.80
1772mm High Tambour	FR550WT	1772	<b>800</b>	470	70.1	577.80	33.80
1617mm High Tambour	FR500WT	1617	<b>800</b>	470	65.4	573.50	33.80
1462mm High Tambour	FR450WT	1462	<b>800</b>	470	61.0	514.70	33.80
1307mm High Tambour	FR400WT	1307	<b>800</b>	470	56.2	482.60	33.80
1152mm High Tambour	FR350WT	1152	<b>800</b>	470	51.0	458.00	33.80
997mm High Tambour	FR300WT	997	<b>800</b>	470	45.9	408.70	33.80
687mm High Tambour	FR200WT	687	<b>800</b>	470	35.9	374.50	33.80
<b>Freedom Side Tambour 1000mm wide.</b> Price includes levelling feet							
1927mm High Tambour	FR60SDT	1927	<b>1000</b>	470	60.0	673.00	
1772mm High Tambour	FR55SDT	1772	<b>1000</b>	470	56.4	630.20	42.90
1617mm High Tambour	FR50SDT	1617	<b>1000</b>	470	52.6	613.10	42.90
1462mm High Tambour	FR45SDT	1462	<b>1000</b>	470	49.1	574.60	42.90
1307mm High Tambour	FR40SDT	1307	<b>1000</b>	470	45.4	560.70	42.90
1152mm High Tambour	FR35SDT	1152	<b>1000</b>	470	41.7	523.20	42.90
997mm High Tambour	FR30SDT	997	<b>1000</b>	470	38.1	467.60	42.90
687mm High Tambour	FR20SDT	687	<b>1000</b>	470	30.7	428.00	42.90
<b>Freedom Side Tambour 1200mm wide.</b> Price includes levelling feet							
1927mm High Tambour	FR60TET	1927	<b>1200</b>	470	54.3	755.40	45.20
1772mm High Tambour	FR55TET	1772	<b>1200</b>	470	51.2	709.40	45.20
1617mm High Tambour	FR50TET	1617	<b>1200</b>	470	47.4	685.90	45.20
1462mm High Tambour	FR45TET	1462	<b>1200</b>	470	44.4	640.90	45.20
1307mm High Tambour	FR40TET	1307	<b>1200</b>	470	41.2	627.00	45.20
1152mm High Tambour	FR35TET	1152	<b>1200</b>	470	37.5	585.30	45.20
997mm High Tambour	FR30TET	997	<b>1200</b>	470	33.9	560.70	45.20
687mm High Tambour	FR20TET	687	<b>1200</b>	470	27.0	498.60	45.20

Please see page 20 for Freedom Internals

# FREEDOM COMBI:STORE

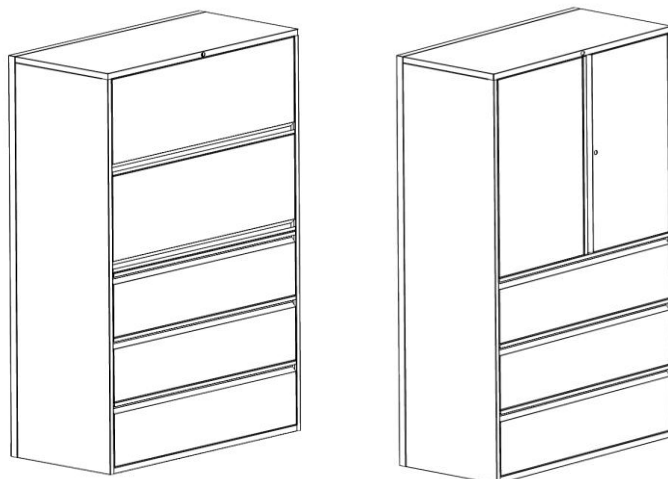

	Code	H (mm)	W (mm)	D (mm)	W (kg)	SD Retail (£)	CK	SL Additional Retail (£)
<b>Cupboard and Drawer Units</b> (with levelling feet) price includes 1 Shelf								
1 X 930mm Cupboard & 3 X Drawers	FR60SDC30D3	1927	1000	470	98.6	1016.50	42.90	8.40
1 X 744mm Cupboard & 3 X Drawers	FR55SDC25D3	1772	1000	470	91.3	935.20	42.90	8.40
1 X 930mm Cupboard & 3 X Drawers	FR600WC30D3	1927	800	470	85.0	952.30	33.80	8.40
1 X 744mm Cupboard & 3 X Drawers	FR550WC25D3	1772	800	470	78.0	867.80	33.80	8.40
<b>Flipper and Drawer Units</b> (with levelling feet) price includes 1 Shelf per 465mm flipper or 1 Lateral rail per 310mm flipper								
2 X 465mm Flippers & 3 X Drawers	FR60SDF15D3	1927	1000	470	94.0	1074.30	42.90	8.40
3 X 310mm Flippers & 3 X Drawers	FR60SDF10D3	1927	1000	470	82.0	1097.80	42.90	8.40
2 X 372mm Flippers & 3 X Drawers*	FR55SDF12D3	1772	1000	470	86.0	942.70	42.90	8.40
2 X 310mm Flippers & 3 X Drawers	FR50SDF10D3	1617	1000	470	82.0	984.40	42.90	8.40
1 X 465mm Flipper & 3 X Drawers	FR45SDF15D3	1462	1000	470	77.0	961.90	42.90	8.40
1 X 465mm Flipper & 2 X Drawers	FR35SDF15D2	1152	1000	470	72.0	771.50	42.90	8.40
2 X 465mm Flippers & 3 X Drawers	FR600WF15D3	1927	800	470	84.0	1079.60	33.80	8.40
3 X 310mm Flippers & 3 X Drawers	FR600WF10D3	1927	800	470	82.4	1067.90	33.80	8.40
2 X 372mm Flippers & 3 X Drawers*	FR550WF12D3	1772	800	470	76.0	876.30	33.80	8.40
2 X 310mm Flippers & 3 X Drawers	FR500WF10D3	1617	800	470	72.0	936.30	33.80	8.40
1 X 465mm Flipper & 3 X Drawers	FR450WF15D3	1462	800	470	67.0	918.10	33.80	8.40
1 X 465mm Flipper & 2 X Drawers	FR350WF15D2	1152	800	470	62.0	727.60	33.80	8.40

\* Includes tie bar and 1 X Shelf

Please see page 20 for additional Freedom Internals

## ACCESSORIES

	Code	Pack Size	Retail
Drawer divider	SLDIV1	Pack 1	8.20

## Coding Key (add the required option code to the end of your chosen product code)

Counter Balance	CK
Same Lock Number	SL

# FREEDOM STORAGE ACCESSORIES

Internals on this page can be used in Freedom units as well as s:l units from s:line

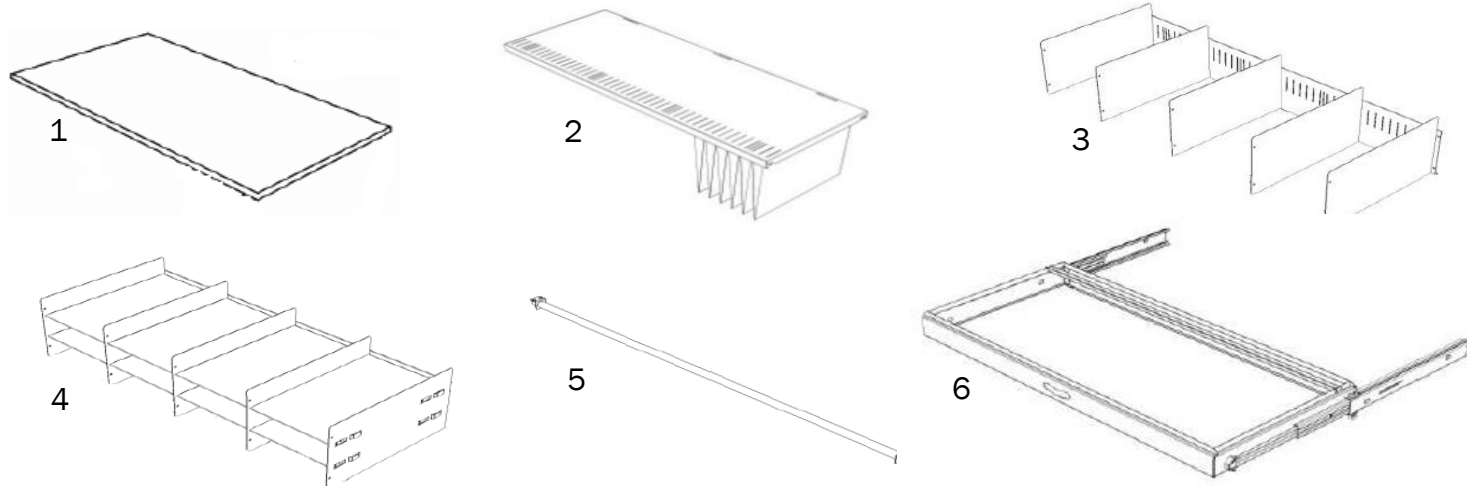

800mm		1000mm		1200mm	
Code	Retail (£)	Code	Retail (£)	Code	Retail (£)

## Freedom Side Opening Tambour Accessories

1. Standard Shelf	SLPSSA1	22.00	SLPSSB1	22.00	SLPSSF1	30.00
2. Multi-purpose Slotted Shelf	SLSSSA1	25.00	SLSSSB1	32.00	SLSSSF1	34.00
3. Divider Kit - 1 Upstand & 5 dividers*	SLSDSA	38.00	SLSDSB	38.00	SLSDSF	38.00
4. Letter Sorter Kit *	SLLSSA	85.00	SLLSSB	95.00	SLLSSF	105.00
5. Coat Rail Shelf Adapter*	SLCRSA	42.30	SLCRSB	47.80	SLCRSF	50.00
6. Roll Out Suspended Filing Frame	SLRSFSA	130.00	SLRSFSB	150.00	SLRSFSF	170.00

## Freedom Cupboard & Combi:store Accessories

1. Standard Shelf	SLPSCA1	22.00	SLPSCB1	22.00	
2. Multi-purpose Slotted Shelf	SLSSCA1	25.00	SLSSCB1	32.00	
3. Divider Kit - 1 Upstand & 5 dividers*	SLSDCA	38.00	SLSDCB	38.00	
4. Letter Sorter Kit *	SLLSCA	85.00	SLLSCB	95.00	
5. Coat Rail Shelf Adapter*	SLCRCA	42.30	SLCRCB	47.80	
6. Roll Out Suspended Filing Frame	SLRSFCA	130.00	SLRSFCB	150.00	

## Freedom Coat Cupboard Accessories

5. Coat Shelf	SLCSCCA1	53.50	SLCSCCB1	61.00	
---------------	----------	-------	----------	-------	--

## Freedom Drawer Accessories

Drawer divider. Pk 1	SLDIV1	8.20	SLDIV1	8.20	
----------------------	--------	------	--------	------	--

\* For items 3, 4 and 5 please ensure item 2 is also ordered (Shelves do not come with Divider kit, letter sorter or coat rail adapters)

Freedom Internals are supplied in Semi gloss black - 023 as standard  
Multi-purpose slotted shelf has 330mm lateral filing capacity as standard

# COLOUR MATRIX

Colour	Code	Pricing	Exemptions
Brown & beige	001	std	
Light Grey - Ral 7035	002	std	
Black - Ral 9005	003	std	
Coffee & Cream	004	std	
Cream	005	std	
Coffee	006	std	
Beige - BS08B17	007	std	
Brown - BS08B29	008	std	
Satin White - Ral 9010	017	Band C	
White	009	Band C	
Red - Ral 3002	010	Band A	
Blue - Ral 5017	011	Band A	
Graphite Grey - Ral 7024	012	std	
Goose Grey - BS00A05	042	std	
Silver - Ral 9006	052	Band A	No surcharge for Silver on Pedestal range
Almond White	054	Band C	
British Racing Green - BS381C226	064	Band A	
Peppermint Green - BS16C33	078	Band A	
Traffic White - Ral 9016	169	Band C	
Traffic Purple	176	Band B	
Sand	240	Band B	
Hession Textured	241	Band B	
Chlorophyll	242	Band B	
Verdigris	243	Band A	
Sienna Orange	244	Band B	
Honey Yellow	245	Band B	
Hickory Green	246	Band B	
Ocean Cobalt	247	Band A	

When specifying combinations of colours the highest price is applicable

## BLIND OPTIONS

Code	Base colours	Kontrax	m:line	Freedom	Vertical Tambours
Smooth Finish Blinds (E)					Plastic fronted
002	Grey	std	std	std	std
003	Black	std	std	std	Band A
007	Beige	std	std	std	
009	White*		Band C	Band C	
010	Red*		Band A	Band A	
011	Blue*		Band A	Band A	
012	Graphite	Band A	Band A	std	std
052	Silver	Band A	Band A	Band A	
<i>Satin and Silk Range</i> Exclusive to s:line and m:line					
31	Silk Lime*		std	std	
32	Silk Graphite*		std	std	
33	Satin Claret*		std	std	
34	Satin Navy		std	std	
<i>Ice Range</i> Exclusive to s:line and m:line					
12	Blue (ice)*		Band B	Band B	
13	Lime (ice)*		Band B	Band B	
14	Orange (ice)*		Band B	Band B	
15	White (ice)*		Band B	Band B	
<i>ime Range</i> Exclusive to s:line and m:line					
22	Oak (ime)*		Band A	Band A	
23	Beech (ime)*		Band A	Band A	
25	Maple (ime)*		Band A	Band A	

Note: Minimum quantities of 10 apply on ice, ime, satin & silk and non standard blind colours and sizes including 1200mm wide blinds.

### Coding Key (add the required option code to the end of your chosen product code)

Standard Pricing	std	10% Premium on standard pricing	Band B
5% Premium on standard pricing	Band A	15% Premium on standard pricing	Band C

# PRODUCT COMPARISON REFERENCE MATRIX

	G	AT	m - AT	LF	FS	A4	A3	Fira	FT
<b>Filing Cabinet</b>									
Kontrax	5	●			●			●	●
Executive	15	●			●	●		●	
m:line	15		●		●	●		●	
<b>Side Filer</b>									
UK	10	●		●	●	●		●	
Double	10	●		●		●		●	
m:line*	15		●	●	●	●		●	
<b>Specialist Storage</b>									
Media Filing	15		●					●	
A3 Jumbo	15		●				●	●	
5 Drawer Filing Cabinet	15		●		●	●			
<b>Storage</b>									
Combi:store*	10		●	●	●	●			
Vertical Tambour	5	●			●	●		●	
Kontrax Side Tambour	5	●		●	●	●		●	●
m:line Side Tambour*	15		●	●	●	●		●	
Kontrax Cupboard*	5	●		●	●	●		●	●
Executive Cupboard*	10	●		●	●	●		●	
Open Fronted Cupboard	5	●		●	●	●			
<b>Other</b>									
Pedestals	5	●			●	●		●	
Caddy Pedestals	5	●			●	●		●	
G3 Combi:Ped	5	●			●	●			
Multi Drawers	5							●	
Lockers	5								
<b>Freedom</b>									
Side Filer	10	●		●	●	●		●	
Cupboard	10	●		●	●	●		●	
Side Tambour	10	●		●	●	●		●	
Combi Unit	10	●		●	●	●		●	

## Key

Guarantee	G	A4 Filing option available	A4*
Anti - Tilt Locking Mechanism	AT	A3 Filing	A3
m:line Anti Tilt Locking Mechanism	m - AT	Fira Certified product	Fira*
Levelling Feet	LF*	Fast Track item	FT*
Fooscap Filing	FS		see our Freedom Range

\* Not available on entire product range. Rules may apply. Please contact our sales office for more information

# INTERNAL DIMENSIONS

		H (mm)	W (mm)	D (mm)
<b>Filing Cabinet Filing Drawer Internal Dimensions</b>				
Kontrax FS	FCEC_F	280	387	445
Midi FS	FCMI_F	280	387	525
Midi A4	FCMI_A	280	327	525
Executive FS	FCEX_F	280	387	525
Executive A4	FCEX_A	280	327	525
m:line FS	FCML_F	280	387	570
m:line A4	FCML_A	280	327	570
<b>Side Filer Drawer Internal Dimensions. See also Freedom Internal Dimensions</b>				
UK	SFUK_D	280	710	415
Double	SFCT_D	280	710	570
m:line 800mm wide - Discontinued	SFLM_DOW	280	710	415
m:line 1003mm wide - Discontinued	SFLM_DSD	280	910	415
<b>Flip Top Box Internal Dimensions</b>				
UK Flip Top Box	SFUKFT	335	760	436
<b>Media Filing Cabinet Internal Drawer Dimensions</b>				
8 Drawer	CIUR86	140	325	570
6 Drawer	CIUR65	180	480	570
5 Drawer	CIUR55	185	685	400



# INTERNAL DIMENSIONS

		H (mm)	W (mm)	D (mm)
<b>A3 Jumbo &amp; 5 Drawer Filing Cabinet Drawer Internal Dimensions</b>				
A3 Jumbo	FCJBA3	375	480	570
5 Drawer Cabinet FS	FCUR5F	270	387	570
5 Drawer Cabinet A4	FCUR5A	270	327	570
<b>Combi:store Internal Cupboard Flipper &amp; Drawer Dimensions. See also Freedom Internal Dimensions</b>				
915mm Cupboard - Discontinued	CSD378	1074	960	440
762mm Cupboard - Discontinued	CSD372	780	960	440
Combi:store Filing Drawer - Discontinued	CSD__	280	910	415
376mm Flipper - Discontinued	CSD_FU	335	960	440
<b>Vertical Tambours Internal Dimensions</b>				
2210mm high	SC_V87	1891	913	410
1830mm high	SC_V72	1511	913	410
<b>m:line &amp; Kontrax Side Tambour Internal Dimensions. See also Freedom Internal Dimensions</b>				
2210mm High Tambour 803mm wide	STLM80W	2025	713	446
2000mm High Tambour 803mm wide	STLM70W / SCST7E0W	1815	713	446
1651mm High Tambour 803mm wide	STLM60W / SCST6E0W	1466	713	446
1320mm High Tambour 803mm wide	STLM90W / SCST9E0W	1135	713	446
1200mm High Tambour 803mm wide	STLM50W	1015	713	446
1016mm High Tambour 803mm wide	STLM40W / SCST4E0W	876	713	446
690mm High Tambour 803mm wide	STLM20W / SCST2E0W	550	713	446
2210mm High Tambour 1003mm wide	STLM8SD	2025	913	446
2000mm High Tambour 1003mm wide	STLM7SD / SCST7ESD	1815	913	446
1651mm High Tambour 1003mm wide	STLM6SD / SCST6ESD	1466	913	446
1320mm High Tambour 1003mm wide	STLM9SD / SCST9ESD	1135	913	446
1200mm High Tambour 1003mm wide	STLM5SD	1015	913	446
1016mm High Tambour 1003mm wide	STLM4SD / SCST4ESD	876	913	446
690mm High Tambour 1003mm wide	STLM2SD / SCST2ESD	550	913	446
2210mm High Tambour 1203mm wide	STLM8TE	2025	1054	437
2000mm High Tambour 1203mm wide	STLM7TE / SCST7ETE	1815	1054	437
1651mm High Tambour 1203mm wide	STLM6TE / SCST6ETE	1466	1054	437
1320mm High Tambour 1203mm wide	STLM9TE / SCST9ETE	1135	1054	437
1016mm High Tambour 1203mm wide	STLM4TE / SCST4ETE	876	1054	437
690mm High Tambour 1203mm wide	STLM2TE / SCST2ETE	550	1054	437
<b>Kontrax, Exec &amp; Open Fronted Cupboard Internal Dimensions. See also Freedom</b>				
1950mm High 2 Door Cupboard	CUE_8_ / CUOF78	1772	913	415
1830mm High 2 Door Cupboard	CUE_7_ / CUOF72	1652	913	415
1650mm High 2 Door Cupboard	CUEC6_ / CUOF65	1472	913	415
1020 mm High 2 Door Cupboard	CUE_4_ / CUOF40	842	913	415
690mm High 2 Door Cupboard	CUEC1_ / CUOF27	512	913	415
<b>Multi Drawer Internal Dimensions</b>				
Storage Drawer	MDUR__	49	233	264
<b>Locker Compartment Internal Dimensions</b>				
1 Tier Compartment 305mm deep	LK1D22	1674	245	284
2 Tier Compartment 305mm deep	LK2D22	810	245	284
3 Tier Compartment 305mm deep	LK3D22	523	245	284
4 Tier Compartment 305mm deep	LK4D22	379	245	284
6 Tier Compartment 305mm deep	LK6D22	235	245	284
1 Tier Compartment 458mm deep	LK1D28	1674	245	436
2 Tier Compartment 458mm deep	LK2D28	810	245	436
3 Tier Compartment 458mm deep	LK3D28	523	245	436
4 Tier Compartment 458mm deep	LK4D28	379	245	436
6 Tier Compartment 458mm deep	LK6D28	235	245	436

# FILING WITH SILVERLINE STORAGE ACCESSORIES

Description	Code	A4 Filing	A4 Filing	Foolscap Filing	Foolscap Filing
Dual Purpose Shelf (330mm hanging)*	CAPSP	1 Row			
Lateral Filing Frame*	CALFP1	1 Row			
Roll Out Filing Frame *	CARFP1	1Row			2 Rows
UK Side Filer Drawer	SFUK		2 Rows	1 Row	
Double Side Filer Drawer	SFCT		2 Rows		
m:line Side Filer Drawer	SFLM		2 Rows	1 Row	2 Rows
Combi:store drawer	CSD_		2 Rows	1 Row	2 Rows

\* Where more than one filing option is shown only one way can be filed at any one time

# FREEDOM CAPACITY PLANNING

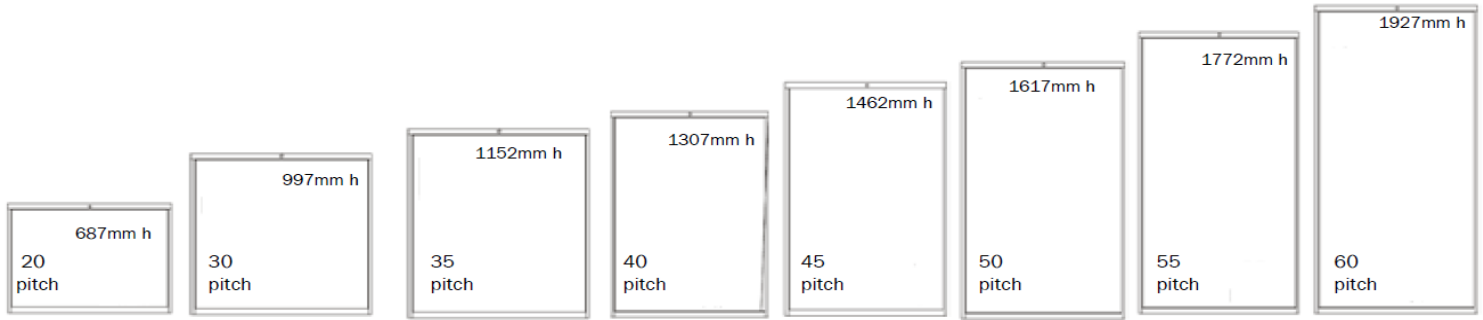

67mm = outer carcass and levelling feet

1 pitch = 31mm

	800mm wide	1000mm wide	1200mm wide
<b>Cupboard</b>			
RSF: Left to Right	654	854	
Shelf - On Shelf filing	762	962	
Shelf - Under Shelf Filing	722	922	
<b>Tambour</b>			
RSF: Left to Right	532	692	892
Shelf - On Shelf filing	640	800	1000
Shelf - Under Shelf Filing	600	760	960
<b>Side Filer</b>			
Suspended Filing - Front to back	375 x 2 (A4 only)	375 x 2	
Suspended Filing - Left to Right	708	908	
<b>Flipper</b>			
On Shelf Filing	762	962	

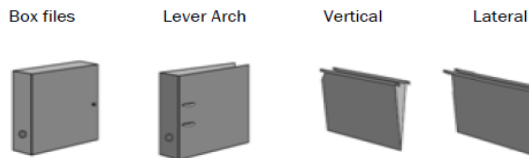

	Box files	Lever Arch	Vertical	Lateral
Foolscap h	368	350	240	375
w	75	75		
d	265	285	360	330
A4 h	337	313	235	

# FREEDOM SPACE UTILISATION

Filing Position	Centres	Pitches
Suspended filing: A4 & foolscap	279mm	9
Suspended filing: A4 & foolscap	310mm	10
Lateral filing: 275 & 330	310mm	10
A4 Lever arch: shelf filing	372mm	12
A4 Lever arch: drawer filing	310mm	10
Foolscap Lever arch: shelf filing	403mm	13
Foolscap Lever arch: drawer filing	310mm	10
A4 Box files: shelf filing	403mm	13
A4 Box files: drawer filing	310mm	10
Foolscap Box files: shelf filing	434mm	14
Foolscap Box files: drawer filing	310mm	10

Example: Customer requires unit for 4 X lever arch filing on shelf

Internals required = 3 X slotted shelf + bottom plinth

50 pitched unit = 2 pitches spare (62mm)

60 pitched unit = 12 pitches spare (372mm)

A4 lever arch, on shelf filing = 12 pitches. (4 X 12 = 48 pitches)

Suitable units = 50, 55 & 60 pitch high.

55 pitched unit = 7 pitches spare (217mm)

(or 60 pitched unit + 1 extra level)

# FREEDOM INTERNAL DIMENSIONS

		H (mm)	W (mm)	D (mm)*
<b>Side Filer &amp; Combination unit 10 pitch drawer Internal Dimensions</b>				
Freedom 800mm wide, 10 pitch	FR__OWD_	295	708	426
Freedom 1000mm wide, 10 pitch	FR__SDD_	295	908	426
<b>Cupboard Internal Dimensions</b>				
Freedom 800mm wide, 60 pitch, 1927mmh cupboard	FR600WC	1863	760	450
Freedom 800mm wide, 55 pitch, 1772mmh cupboard	FR550WC	1708	760	450
Freedom 800mm wide, 50 pitch, 1617mmh cupboard	FR500WC	1553	760	450
Freedom 800mm wide, 45 pitch, 1462mmh cupboard	FR450WC	1398	760	450
Freedom 800mm wide, 40 pitch, 1307mmh cupboard	FR400WC	1243	760	450
Freedom 800mm wide, 35 pitch, 1152mmh cupboard	FR350WC	1088	760	450
Freedom 800mm wide, 30 pitch, 997mmh cupboard	FR300WC	933	760	450
Freedom 800mm wide, 20 pitch, 687mmh cupboard	FR200WC	623	760	450
Freedom 1000mm wide, 60 pitch, 1927mmh cupboard	FR60SDC	1863	960	450
Freedom 1000mm wide, 55 pitch, 1772mmh cupboard	FR55SDC	1708	960	450
Freedom 1000mm wide, 50 pitch, 1617mmh cupboard	FR50SDC	1553	960	450
Freedom 1000mm wide, 45 pitch, 1462mmh cupboard	FR45SDC	1398	960	450
Freedom 1000mm wide, 40 pitch, 1307mmh cupboard	FR40SDC	1243	960	450
Freedom 1000mm wide, 35 pitch, 1152mmh cupboard	FR35SDC	1088	960	450
Freedom 1000mm wide, 30 pitch, 997mmh cupboard	FR30SDC	933	960	450
Freedom 1000mm wide, 20 pitch, 687mmh cupboard	FR20SDC	623	960	450
Freedom 800mm wide, Coat Cupboard	FR600WCC	1863	760	450
Freedom 1000mm wide, Coat Cupboard	FR60SDCC	1863	960	450
<b>Combination Flipper Internal Dimensions</b>				
Freedom 800mm wide, 15 pitch, 465mmh flipper		413	760	448
Freedom 800mm wide, 12 pitch, 372mmh flipper		320	760	448
Freedom 800mm wide, 10 pitch, 310mmh flipper		258	760	448
Freedom 1000mm wide, 15 pitch, 465mmh flipper		413	960	448
Freedom 1000mm wide, 12 pitch, 372mmh flipper		320	960	448
Freedom 1000mm wide, 10 pitch, 310mmh flipper		258	960	448
<b>Side Tambour Internal Dimensions</b>				
Freedom 800mm wide, 60 pitch, 1927mmh Side Tambour	FR600WT	1863	741	443
Freedom 800mm wide, 55 pitch, 1772mmh Side Tambour	FR550WT	1708	741	443
Freedom 800mm wide, 50 pitch, 1617mmh Side Tambour	FR500WT	1553	741	443
Freedom 800mm wide, 45 pitch, 1462mmh Side Tambour	FR450WT	1398	741	443
Freedom 800mm wide, 40 pitch, 1307mmh Side Tambour	FR400WT	1243	741	443
Freedom 800mm wide, 35 pitch, 1152mmh Side Tambour	FR350WT	1088	741	443
Freedom 800mm wide, 30 pitch, 997mmh Side Tambour	FR300WT	933	741	443
Freedom 800mm wide, 20 pitch, 687mmh Side Tambour	FR200WT	623	741	443
Freedom 1000mm wide, 60 pitch, 1927mmh Side Tambour	FR60SDT	1863	941	443
Freedom 1000mm wide, 55 pitch, 1772mmh Side Tambour	FR55SDT	1708	941	443
Freedom 1000mm wide, 50 pitch, 1617mmh Side Tambour	FR50SDT	1553	941	443
Freedom 1000mm wide, 45 pitch, 1462mmh Side Tambour	FR45SDT	1398	941	443
Freedom 1000mm wide, 40 pitch, 1307mmh Side Tambour	FR40SDT	1243	941	443
Freedom 1000mm wide, 35 pitch, 1152mmh Side Tambour	FR35SDT	1088	941	443
Freedom 1000mm wide, 30 pitch, 997mmh Side Tambour	FR30SDT	933	941	443
Freedom 1000mm wide, 20 pitch, 687mmh Side Tambour	FR20SDT	623	941	443
Freedom 1200mm wide, 60 pitch, 1927mmh Side Tambour	FR60TET	1863	1141	443
Freedom 1200mm wide, 55 pitch, 1772mmh Side Tambour	FR55TET	1708	1141	443
Freedom 1200mm wide, 50 pitch, 1617mmh Side Tambour	FR50TET	1553	1141	443
Freedom 1200mm wide, 45 pitch, 1462mmh Side Tambour	FR45TET	1398	1141	443
Freedom 1200mm wide, 40 pitch, 1307mmh Side Tambour	FR40TET	1243	1141	443
Freedom 1200mm wide, 35 pitch, 1152mmh Side Tambour	FR35TET	1088	1141	443
Freedom 1200mm wide, 30 pitch, 997mmh Side Tambour	FR30TET	933	1141	443
Freedom 1200mm wide, 20 pitch, 687mmh Side Tambour	FR20TET	623	1141	443

\* Depth measured is from behind closure to the back of the unit

# SILVERLINE / RAILEX STANDARD FILES

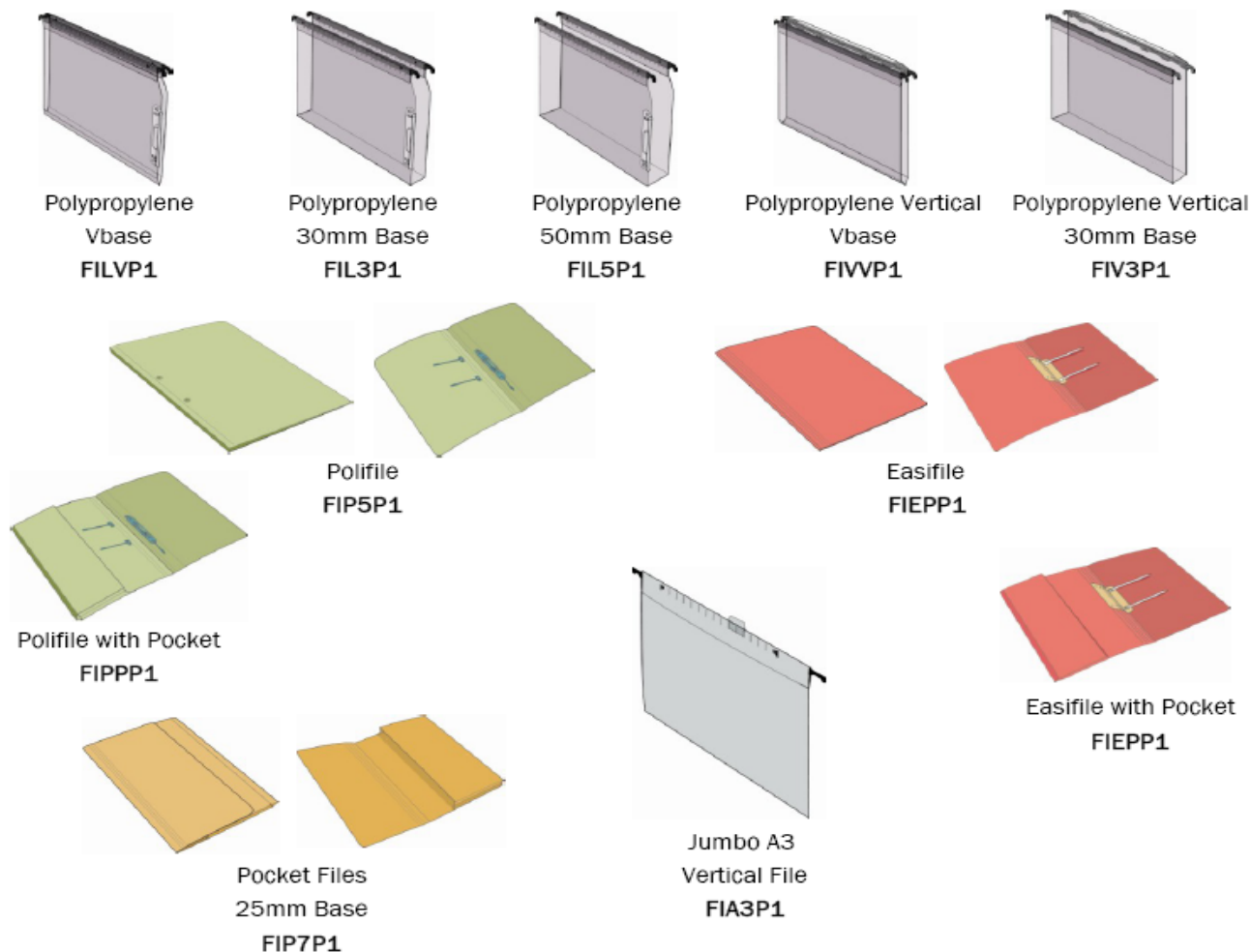

Description	Reference	Pack Quantity	Silverline Customer Nett Pack Price
Easifiles, foolscap size	FIE7P1SD (E7)	50	44.50
Easifiles, foolscap size with pocket	FIEPP1SD (EP7)	50	58.51
Polifile, foolscap size	FIP5P1SD (PL5)	50	67.59
Polifile, foolscap size with pocket	FIPPP1SD (PL5P)	50	85.99
Polypropylene V base 11" drop	FILVP1SD (LFV-PP)*	25	37.13
Polypropylene 30mm base 11" drop	FIL3P1SD (LF30-PP)*	25	43.94
Polypropylene 50mm base 11" drop	FIL5P1SD (LF50-PP)*	25	47.03
Polypropylene vertical V base	FIVVP1SD (VKF/V-PP)*	25	48.15
Polypropylene vertical 30mm base	FIV3P1SD (VKF/30-PP)*	25	51.31
Medical Box, black (Not Shown)	FIMTP1SD (MT57)	24	146.10
Jumbo A3 vertical file (Available in emerald only)	FIA3P1SD (SIL/A3)	50	150.45
Pocket file foolscap size	FIP7P1SD (PF7)	50	40.08
Access Polifile foolscap Ivory	FIA5P1SD (AP5)	25	31.31
Easifile Inset Modules for above 1st/2nd/3rd	FIM6P1SD (MF64/E)	100	59.32

Easifiles and Polifiles are available in:

024 Ivory : 118 Turquoise : 172 Emerald : 173 Mandarin : 185 Pearl : 186 Cerise : 174 Gold : 187 Ruby : 000 Clear

Pocket files are available in:

024 Ivory : 118 Turquoise : 172 Emerald : 173 Mandarin : 186 Cerise

\* Polypropylene Files clear only Please note: File prices above are fixed retail prices and are not subject to discount

Minimum order value of £50 applies on all railex files. Orders under the minimum order value are subject to a carriage charge. Please contact our sales office for more information.

# A NOTE ABOUT ORDERING

When ordering, make sure that the correct codes are used. Our codes comprise of three parts which describe every aspect of the product that is being ordered and ensures that it is correctly identified on our computer system.

1. Select a product to be ordered from the lists on pages 3-17. Make a note of the 6 digit cat No. For Example, if a m:line 4 drawer filing cabinet, (Foolscap), was being ordered the Cat No. is FCLM4F.
2. Examine the options relevant to each section and select any variation from the standard model that might be required. Note down the two digit option code. For standard models always use SD. For example, if the m:line filing cabinet required a security bar, SB would be added.
3. Now examine the colour matrix on page 18 and select the required colour. Note there is an extra charge for some colours. Make a note of the three digit colour code at the top of the chart. For example, if the colour required was Graphite Grey, RAL7024, the code would be 012.

Following the example above, would give us the code shown below.

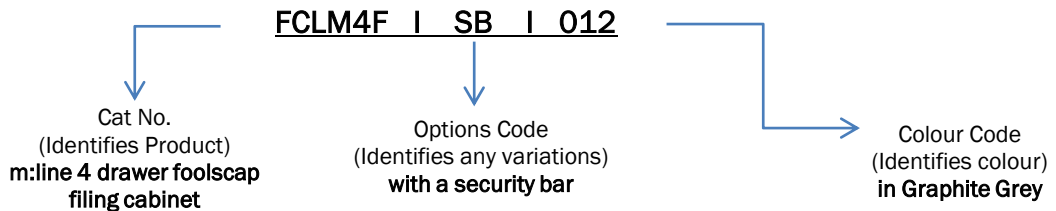

This system is designed to make placing an order as simple as possible. The codes give exact details about the product being purchased so you know exactly what has been ordered and our Sales Team are able to process your order accurately and quickly.

Note: Remember to specify your Tambour Blind when ordering a m:line or Freedom Side Tambour.

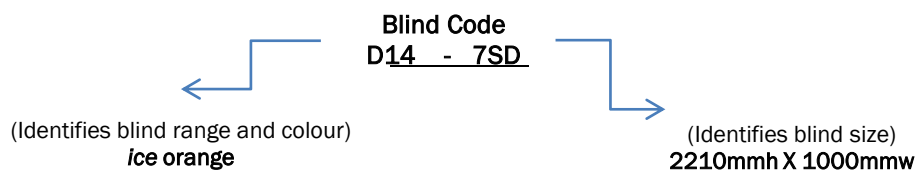

Some of the information in this brochure may be incorrect due to product / information changes which may have occurred since it was printed. Before ordering, please ask our Sales Team for the latest information.

The company reserves the right to make changes at any time, without notice, to prices, colour, materials, specification and models. Please Note; All weights are for guideline purposes only.

Where product weights are a specific requirement please contact our sales office for technical data.

**Prices are subject to change with the steel market volatility**



**Silverline London Showroom**

21-22 Great Sutton Street  
Clerkenwell  
London  
EC1V 0DY  
Tel: +44(0)20 7253 7652

**Silverline Office Equipment Ltd**

James Carter Road  
Mildenhall Industrial Estate  
Mildenhall  
Suffolk  
IP28 7DE

Tel: +44(0)1638 582 700  
Fax: +44(0)1638 582 714  
[enquiries@silverline-oe.com](mailto:enquiries@silverline-oe.com)  
[www.silverline-oe.com](http://www.silverline-oe.com)  
[www.silverlinegraphiccentre.co.uk](http://www.silverlinegraphiccentre.co.uk)  
[enquiries@s-line.co.uk](mailto:enquiries@s-line.co.uk)  
[www.s-line.co.uk](http://www.s-line.co.uk)

August 2010 Price List V3d

Price List published Sept 2010

**Silverline Storage: Making Standard Extra Special**